

TOSHIBA RF POWER AMPLIFIER MODULE

**S-AV17**

VHF 50W FM RF POWER AMPLIFIER MODULE

HAM Application

Unit in mm

MAXIMUM RATINGS (Tc = 25°C)

CHARACTERISTIC		SYMBOL	RATING	UNIT
DC Supply Voltage		VCC	16	V
DC Supply Voltage		VCON	16	V
Total Current		IT	14	A
Input Power		Pi	600	mW
Output Power	@ 12.5V < VCC ≤ 16V VCON ≤ 12.5V Pi = 400mW ZG = ZL = 50Ω	Po	65	W
Operating Case Temperature Range		Tc (opr)	-30~100	°C
Storage Temperature Range		Tstg	-40~110	°C

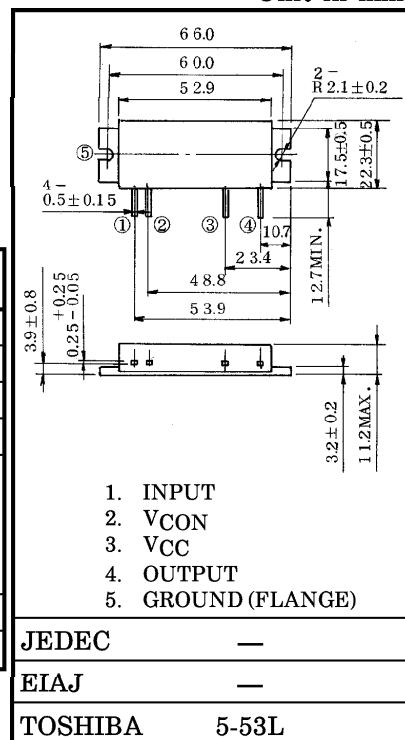

ELECTRICAL CHARACTERISTICS (Tc = 25°C)

Weight : 35g

CHARACTERISTIC	SYMBOL	TEST CONDITION	MIN.	TYP.	MAX.	UNIT
Frequency Range	f <sub>range</sub>	—	144	—	148	MHz
Output Power	Po	Pi = 400mW VCC = VCON = 12.5V ZG = ZL = 50Ω	60	—	—	W
Power Gain	G <sub>p</sub>		21.7	—	—	dB
Total Efficiency	η <sub>T</sub>		45	—	—	%
Input VSWR	VSWR <sub>in</sub>		—	1.5	2.0	—
Harmonics	HRM		—	-30	-25	dB
Load Mismatch	—	Po = 60W (VCON = adjust) VCC = 15V Pi = 400mW VSWR load 20 : 1 all phase	No Degradation			—
Stability	—	VCC = 12.5V VCON = 0~12.5V Pi = 400mW VSWR load 3 : 1 all phase	All spurious output than 60dB below desired signal			—

CAUTION

- This product has intersetting cap. Please pay attention for exceeding stress and foreign matter in your application. And not to take away the cap.
- Beryllia Ceramics is used in this product. The dust or vapor can be dangerous to humans. Do not break, cut, crush or dissolve chemically. Dispose of this product properly according to law. Do not intermingle with normal industrial or domestic waste.

961001EAA2

● TOSHIBA is continually working to improve the quality and the reliability of its products. Nevertheless, semiconductor devices in general can malfunction or fail due to their inherent electrical sensitivity and vulnerability to physical stress. It is the responsibility of the buyer, when utilizing TOSHIBA products, to observe standards of safety, and to avoid situations in which a malfunction or failure of a TOSHIBA product could cause loss of human life, bodily injury or damage to property. In developing your designs, please ensure that TOSHIBA products are used within specified operating ranges as set forth in the most recent products specifications. Also, please keep in mind the precautions and conditions set forth in the TOSHIBA Semiconductor Reliability Handbook.

**SCHEMATIC**

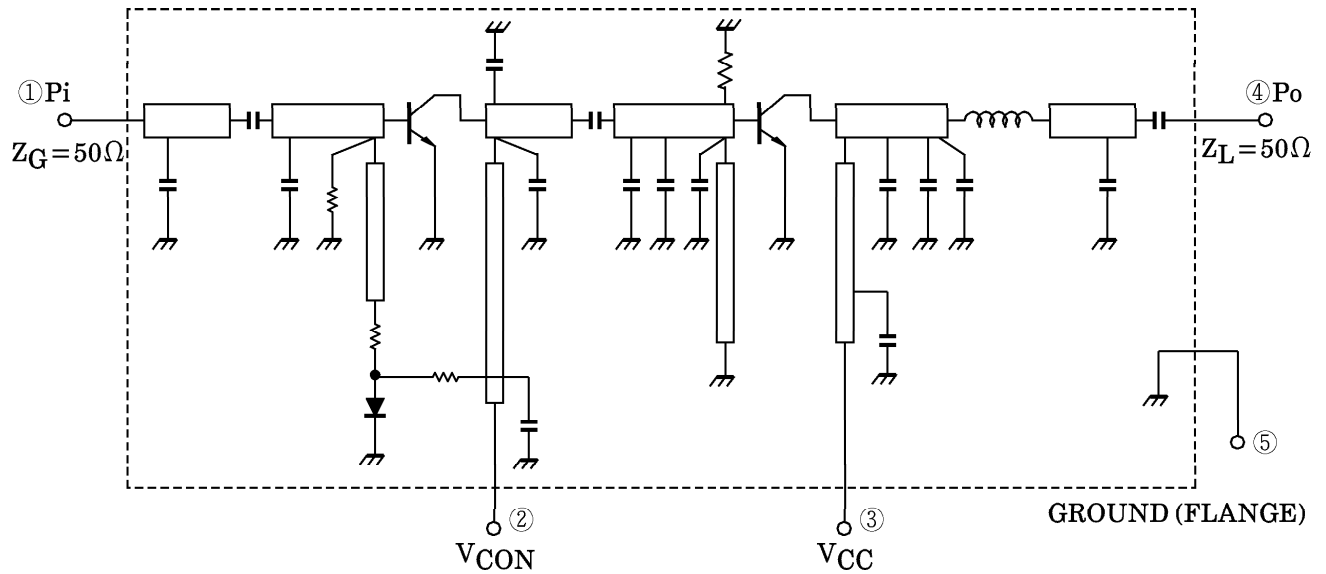

**TEST FIXTURE**

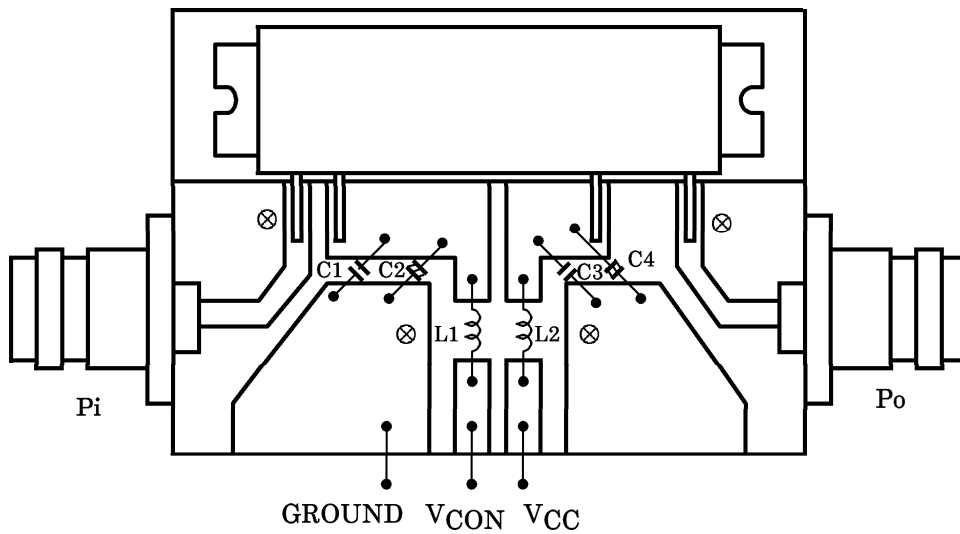

- C1, C3 : 1500pF
- C2, C4 : 10μF
- L1, L2 : φ0.8ENAMEL WIRE, 8T, 5ID

961001EAA2'

● The information contained herein is presented only as a guide for the applications of our products. No responsibility is assumed by TOSHIBA CORPORATION for any infringements of intellectual property or other rights of the third parties which may result from its use. No license is granted by implication or otherwise under any intellectual property or other rights of TOSHIBA CORPORATION or others.  
 ● The information contained herein is subject to change without notice.

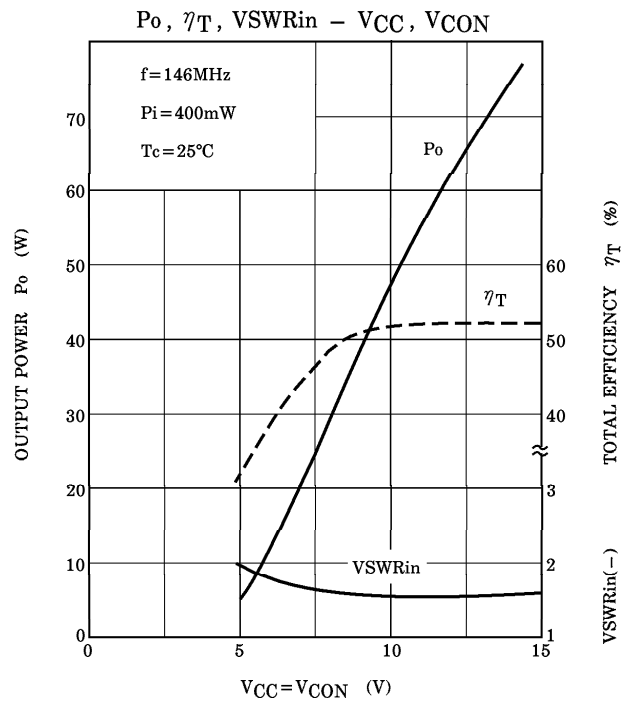
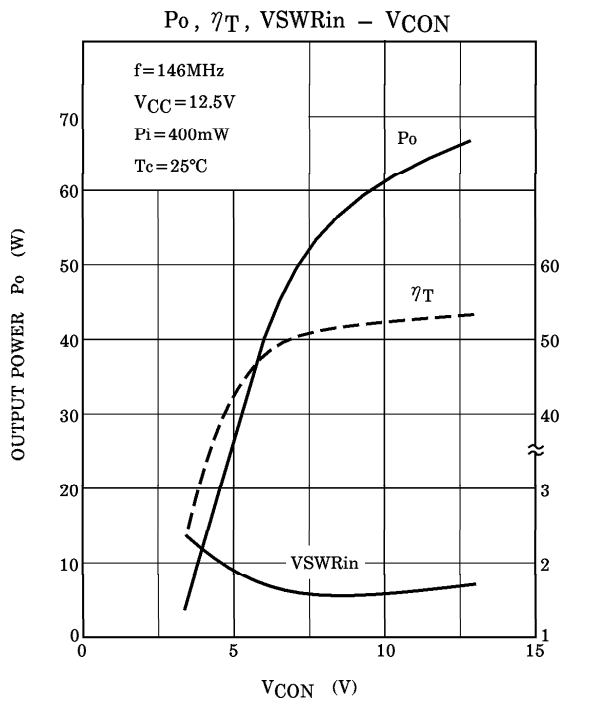
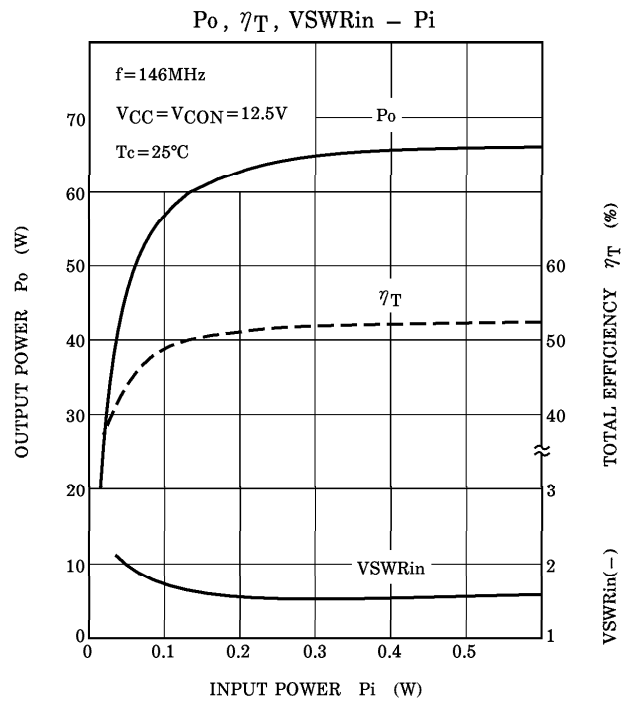
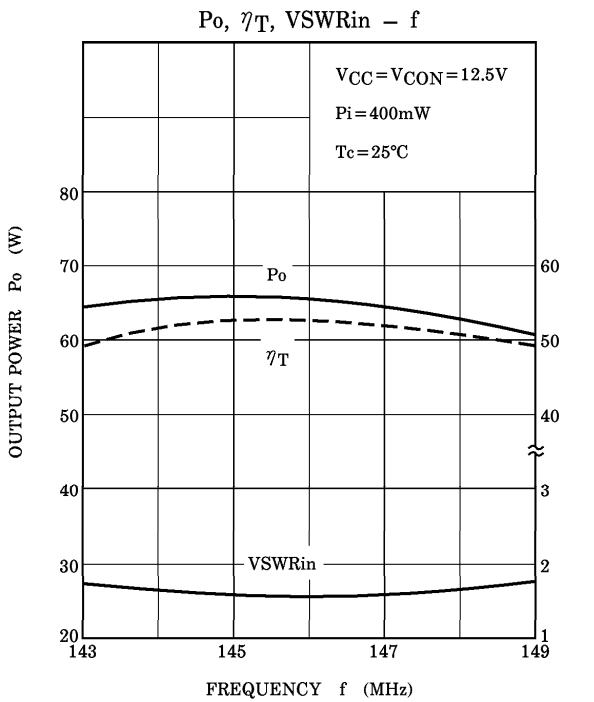

CAUTION

These are only typical curves and devices are not necessarily guaranteed at these curves.